

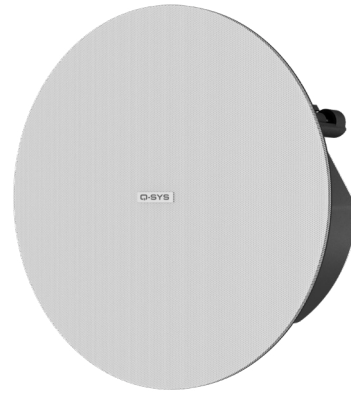

AcousticDesign™ Series AD-C4T-LPZB

KEY FEATURES

- Zero bezel design for the needs of modern applications
- Consistent tonal characteristics across the entire AcousticDesign Series for surface, ceiling, and pendant applications
- DMT (Directivity Matched Transition™) waveguide ensures smooth, uniform frequency response over the coverage area
- Snap-fit magnetic grille
- 3x double stepped, long travel dog-ear blind mount system
- Intrinsic Correction™ voicings available via the Q-SYS Platform including CX-Q amplifiers
- Blemish-free removable logo
- Removable conduit cover plate, also available as accessory for pre-install wiring
- UL1480 and UL2043 certified
- Available in white (RAL 9003), with black grille accessory sold separately
- Complete EASE, CF2, CAD, & BIM information available online



AcousticDesign™ Series AD-C4T-LPZB

4.5" low profile, zero bezel ceiling mount loudspeaker

The Q-SYS AcousticDesign™ AD-C4T-LPZB is a 4.5" two-way, low profile, zero bezel ceiling loudspeaker ideally suited for a wide variety of foreground and background sound reinforcement applications which utilize 70/100V or 16Ω bypass configurations.

The AcousticDesign™ Series offers integrators a premium quality installed sound solution where performance, consistent coverage, and aesthetics are paramount. Specifically designed to maintain a consistent tonal characteristic across the entire family in ceiling, surface, and pendant applications, the AcousticDesign™ series allows integrators seamless transitions within blended installations.

The AD-C4T-LPZB features a high quality 4.5" weather treated paper cone woofer with a 1" voice coil and a .75" aluminum dome tweeter which is positioned on a DMT waveguide.

DMT (Directivity Matched Transition™) is Q-SYS's design philosophy where the high frequency waveguide is matched to the natural conical behavior of the woofer at the crossover point. The result is a coherent transition between transducers with improved off-axis power response for consistent 150° conical DMT coverage.

The accurate frequency response of the AD-C4T-LPZB is maintained even in 70/100V applications by use of a low-loss, low-saturation 30-watt transformer with selectable taps, including 16Ω bypass, using a rotary selector located under the snap-fit magnetically attached powder coat steel grille.

To retain lasting good looks, the rugged ABS baffle is further protected by using UV inhibitors that prevent discoloration and by a powder coated steel back can. The magnetic grille features a stick-on logo that can be removed blemish-free for installations where branding is not permitted.

Installers will appreciate the 3x double stepped, long travel dog-ear blind mounting system, which captures from 0" - 2.25" of ceiling thickness. The conduit cover plate can be easily removed by loosening the single captive Phillips screw allowing access to the locking 4-pole Euro-block connector which can accept up to four 18AWG pairs, eliminating the hassles of star topology wiring designs.

Intrinsic Correction™ voicings that optimize performance and speed the install process are easily deployed via the Q-SYS Platform including CX-Q Series amplifiers.

The AD-C4T-LPZB is available in white (RAL 9003) with black grilles sold separately, and has the ability to be painted to match any decor.

For your system integration needs, complete EASE, CF2, CAD, and BIM files are available for download at Q-SYS.com.



AD-C4T-LPZB

LF transducer	114 mm (4.5 in) weather treated paper cone woofer
HF transducer	19 mm (.75 in) aluminum dome tweeter
Effective frequency range ¹	70 Hz – 20 kHz
Rated noise power / voltage ²	30 W / 22 V (rms)
Sensitivity (dB) ³	87
Rated coverage (-6 dB) ⁴	150° conical DMT
Directivity factor ⁴	4.5
Directivity index (dB) ⁴	6.5
Maximum continuous SPL (dB) ⁵	102
Maximum peak SPL (dB) ⁵	108
Nominal impedance (Ω)	16
Recommended amplifier	60 W
Transformer taps / impedance	Bypass: 16 Ω 3.75 W (70 V); 7.5 W (100 V) Tap: 1333 Ω 7.5 W (70 V); 15 W (100V) Tap: 667 Ω 15 W (70 V); 30 W (100V) Tap: 333 Ω 30 W (70 V); N/A (100V) Tap: 167Ω
Input connector type	Euroblock connector with parallel output
Enclosure material	ABS baffle on powder coated steel back can
Grille material	Powder coated steel
Ingress protection	IP-54
Operating environment	Designed for indoor use
Operating temperature range	-20 to 50° C (-4 to 122° F)
Cutout dimension	Ø 245 mm (Ø 9.65 in)
Net weight	3 kg (6.6 lb)
Product dimensions (D x H)	Ø 280 x 100 mm (Ø 11.02 x 3.93 in)
Shipping weight	10.2 kg (22.5 lb), pair packed
Shipping dimensions (H x W x D)	183 x 699 x 394 mm (7.2 x 27.5 x 15.5 in), pair packed
Included accessories	C-ring and tile rails, rail screws, euroblock connector, cut-out template, grille
Optional accessories	AD-MR6 (pre-install mud ring), AD-C254BG (black ceiling grille)
Safety Agency	UL1480, UL2043, NFPA90, NFPA70 suitable for use in air handling spaces. Transformer UL registered per UL1876, ROHS, CE compliant. Baffle meets UL94-V0 and UL94-5 VB flammability rating; in accordance with IEC60849 / EN60849 systems.

¹ IEC noise, 2hrs² -10dB from rated sensitivity³ Transformer bypassed, 1 W, 1 m, IEC baffle, 200-10 kHz average, on-axis⁴ 500 Hz–5 kHz average⁵ Calculated from rated noise voltage and sensitivity⁶ reference axis.

AD-C4T-LPZB

Impedance/Frequency Response:

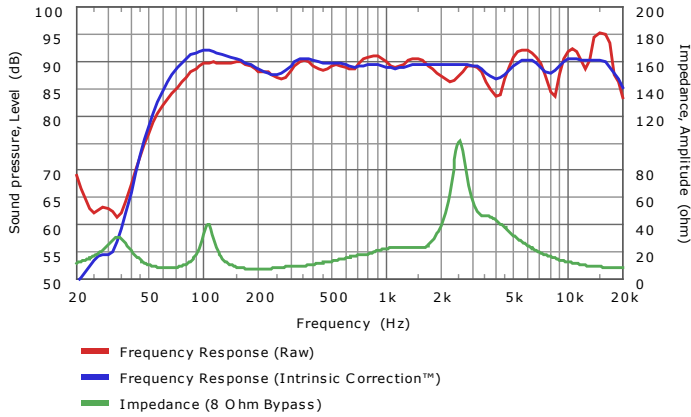

Beamwidth:

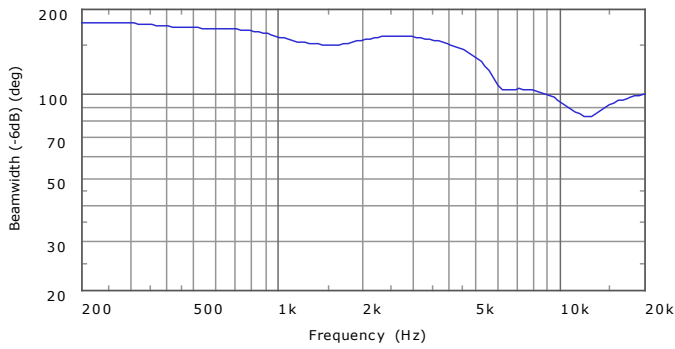

Dimensions

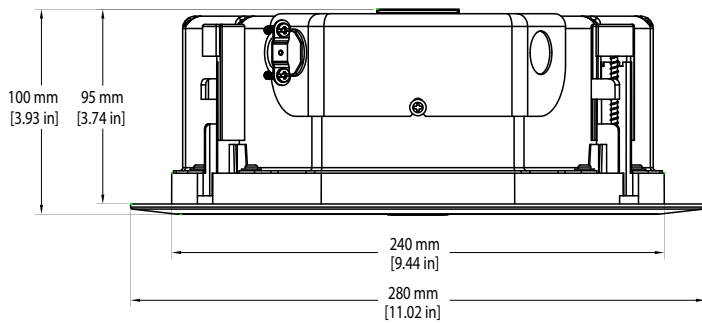

As part of Q-SYS's ongoing commitment to product development, specifications are subject to change without notice.